

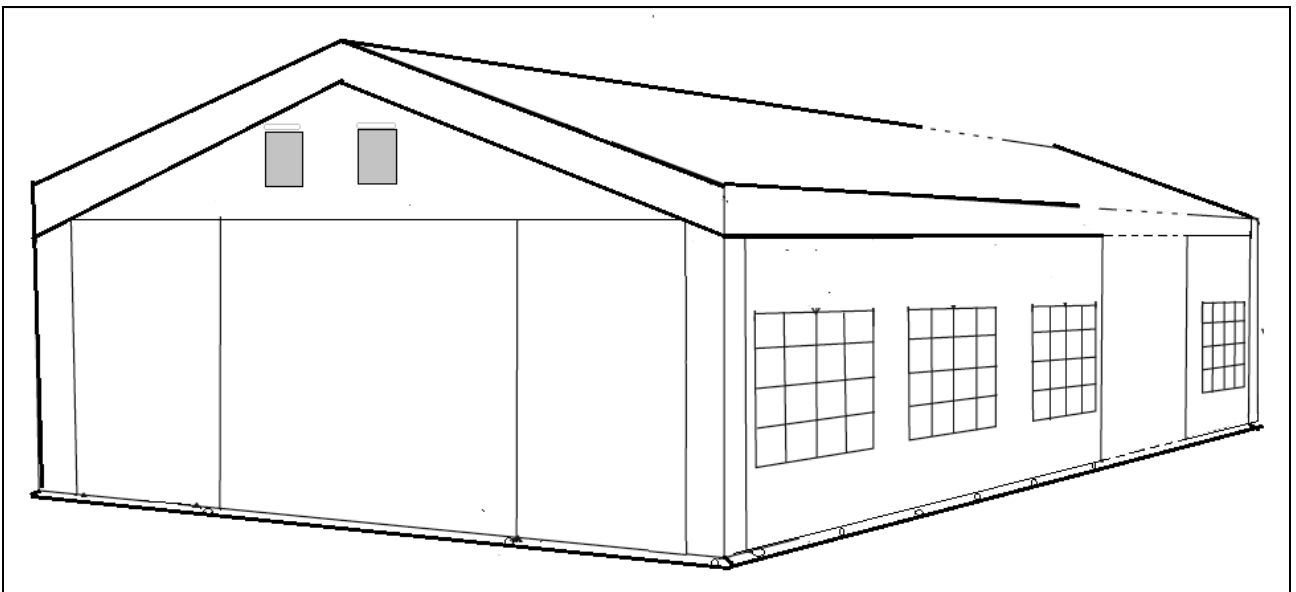



4M Economy



INSTRUCTION MANUAL

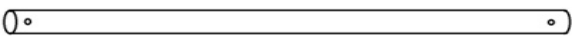
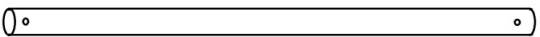
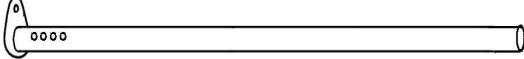
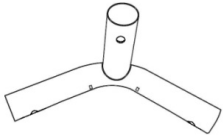
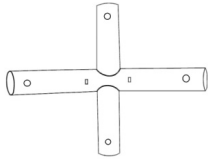
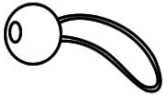
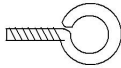

Part List

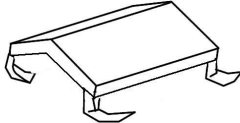
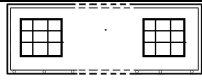
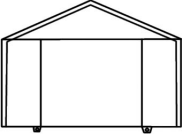
Part no.		Qty			
		4x4m	4x6m	4x8m	4x10m
No.1		6	8	10	12
No.2		6	9	12	15
No.3		6	8	10	12
No.4		6	6	6	6
No.5		3	6	9	12
No.6		56	64	72	80
No.7		30	42	54	66
Nr.8		4	4	4	4
No.9		4	4	4	4
No.10		4	4	4	4
No.11		1	1	1	1
No.12		2	2	2	2
No.13		2	2	2	2

Instruction:

1. Assemble the roof frame by mounting parts 4 and 5 on the pipes (parts 1 and 2). Use the screws to attach the parts.

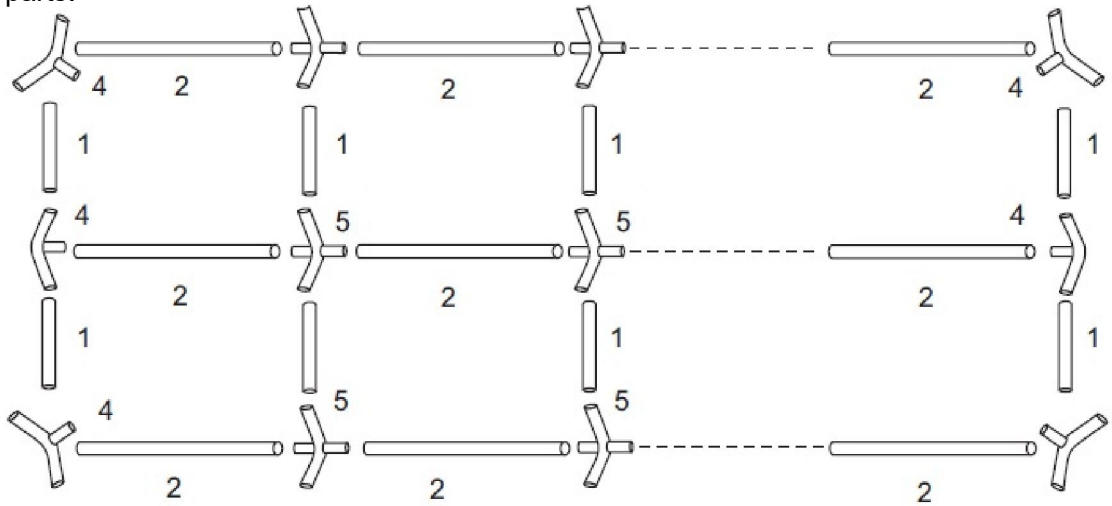

2. Lift one side of the tent frame and attach the legs (3).

Place the roof onto the frame and use the bungees to fasten it. Be sure not to put too much tension on the bungees in order not to make attaching the other side more difficult.

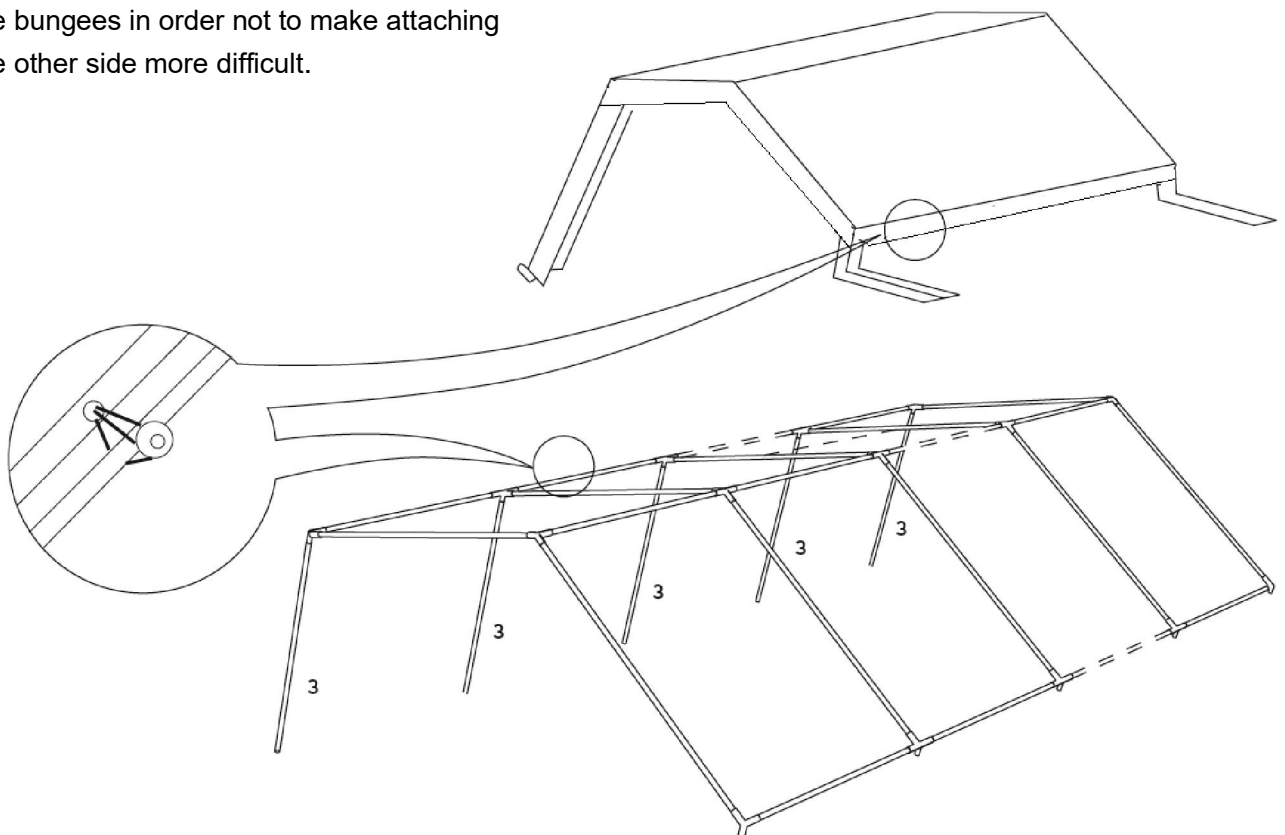

3. Attach the legs on the other side. Make sure, that the leg pipes are in vertical position, to avoid overtention on the endwalls. Attach legcover to the legs with hooks ..

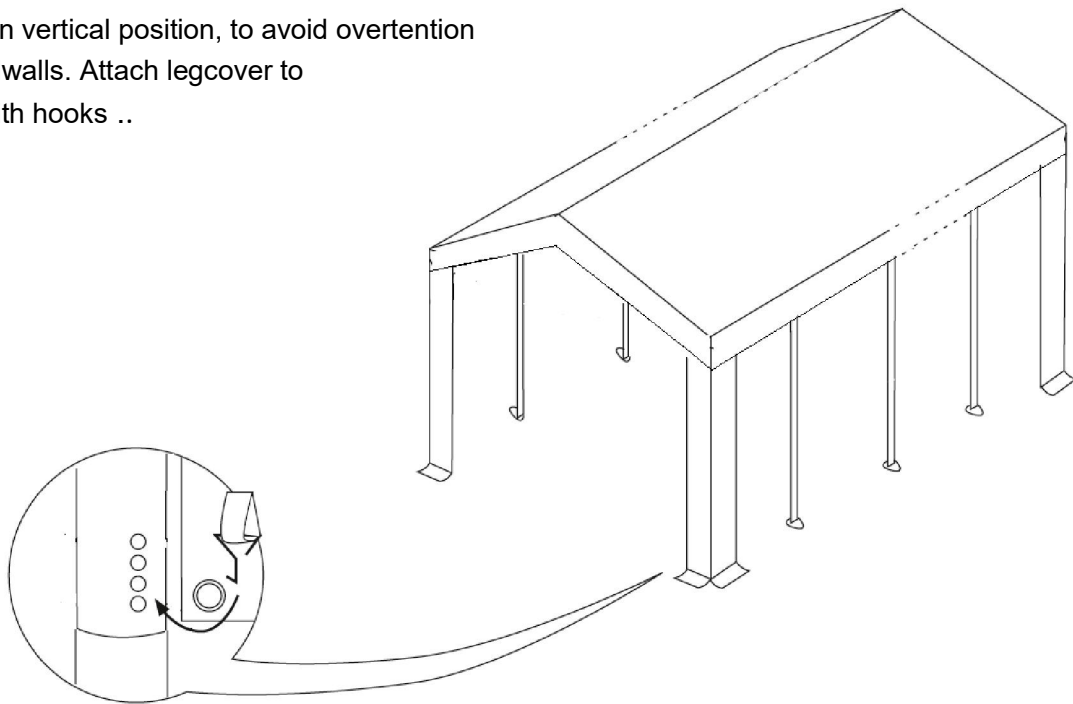

4. Unfold the side walls and the end walls and attach the side walls to the frame using the bungees. Attach the end walls directly to the frame using the bungees. The guy rope runs from every corner of the tent and is braced to the ground using the long ground pegs. Make sure the endwalls and sidewalls are properly attached with each other by Velcro.

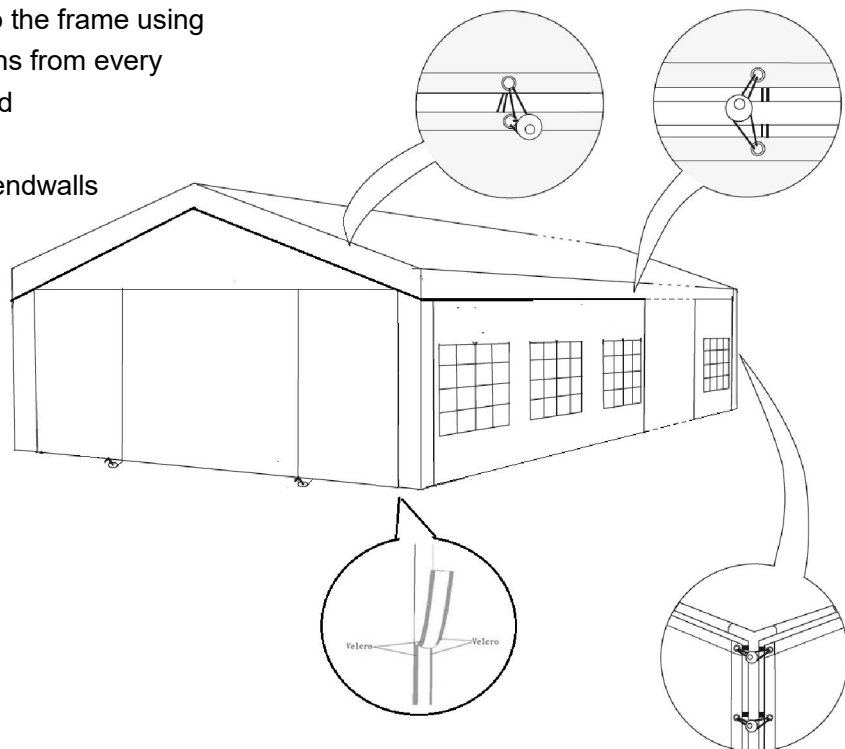

Cleaning and maintenance

Wash off the roof and the side parts with soapy water. Mould and mould stains can be removed using a mild chlorine solution. Observe the instructions provided by the manufacturer and test the chlorine solution on a hidden spot to make sure that there is no discolouration.

Caution! The party tent must not be dismantled and packed up when it is wet. First, allow it to dry completely.

Caution

1. Always handle the tent with care to avoid damage.
2. Do not apply too much pressure to the frame parts to avoid damage.
3. Tents are intended for temporary accommodation and should be taken down in adverse weather conditions.
4. Always be sure to keep sufficient distance to hoses as well as gas and power lines to avoid possible damage.
5. When using suitable heaters (available e.g. in specialist shops), keep a minimum distance of 1.2 m to tarp material.
Open fire or heaters with open flames such as patio heaters, umbrella heaters, gas heaters etc. should not be used in any case.
6. The person setting up the tent is responsible for adequately securing it to ensure its safety.





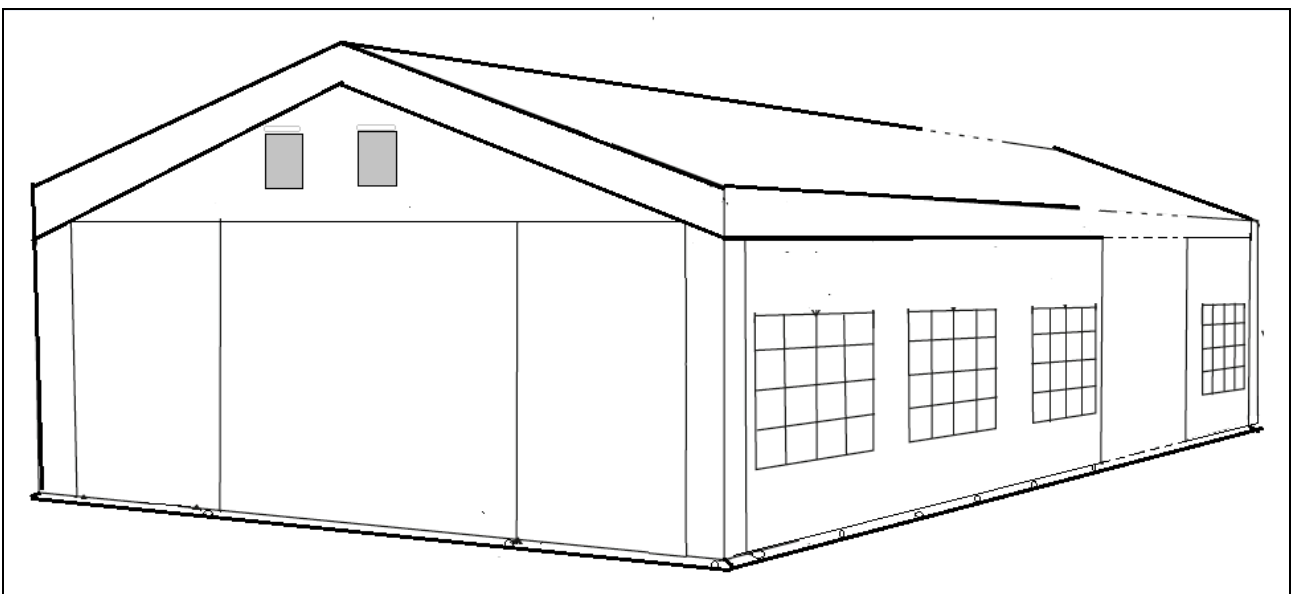

4M Economy

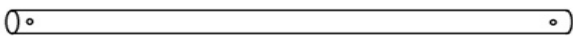
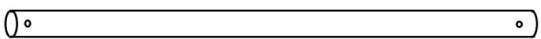
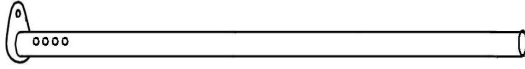
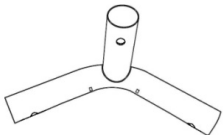
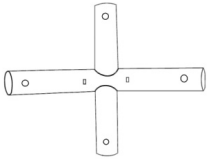
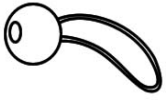
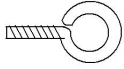

Aufbauanleitung

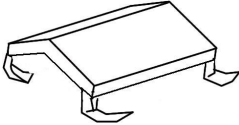

Inhalt

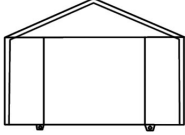
Teil Nr.		Qty			
		4x4m	4x6m	4x8m	4x10m
Nr.1		6	8	10	12
Nr.2		6	9	12	15
Nr.3		6	8	10	12
Nr.4		6	6	6	6
Nr.5		3	6	9	12
Nr.6		56	64	72	80
Nr.7		30	42	54	66
Nr.8		4	4	4	4
Nr.9		4	4	4	4
Nr.10		4	4	4	4
Nr.11		1	1	1	1
Nr.12		2	2	2	2
Nr.13		2	2	2	2

Beschreibung:

2. Als erstes verbinden wir das Dachgestell. Nehmen Sie die Verbinder Nr 4 und Nr 5 und verbinden Sie diese mit den Stangen Nr. 1 und Nr.2.

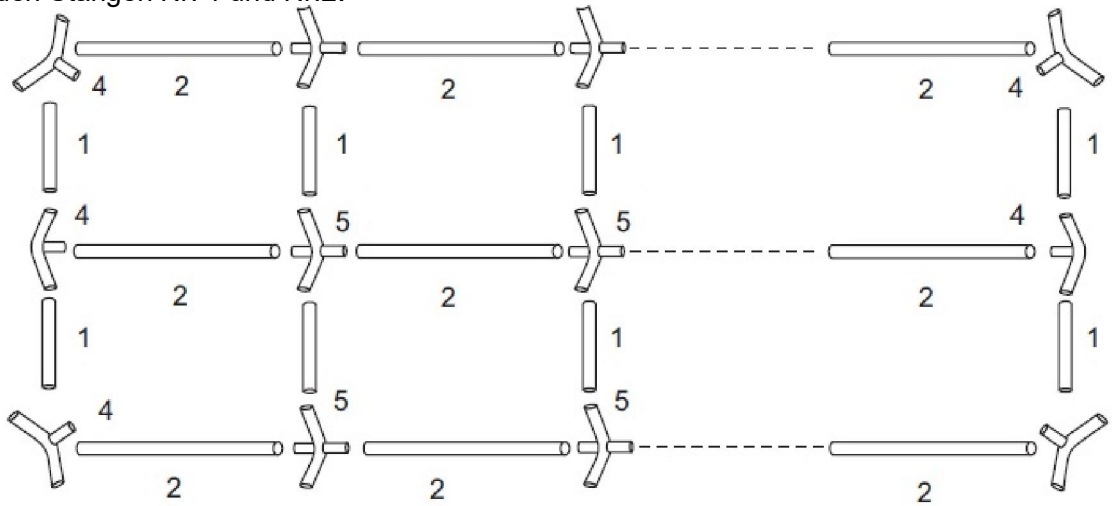

2. Heben Sie eine des Daches und verbinden Sie diese mit den Beinen(Nr.3).

Nehmen Sie die Plane und Befestigen Sie Diese mit den Spanngummis.

Achten Sie darauf diese nicht zu stramm zu ziehen damit Sie die andere Seite leichter Befestigen koennen.

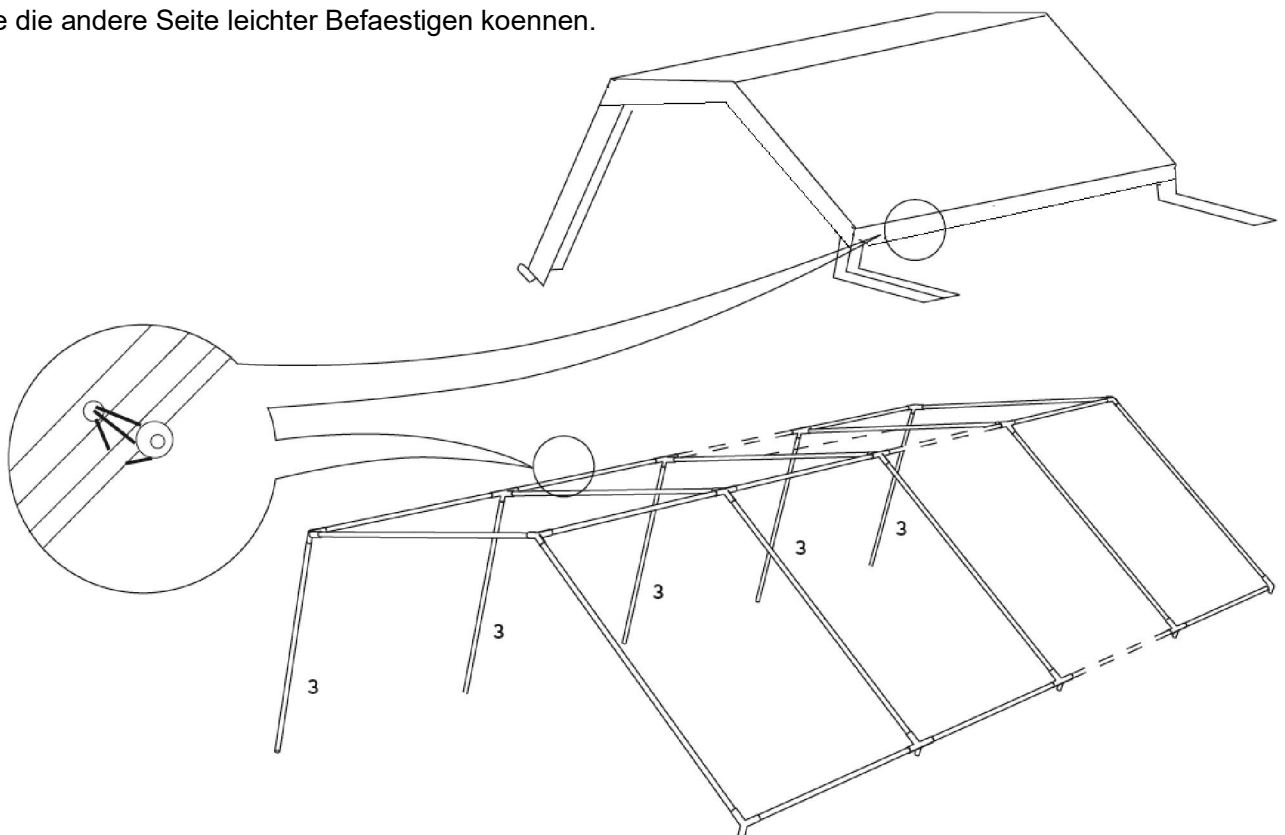

3. Befestigen Sie nun die Beine auf der anderen Seite.

Achten Sie darauf das die Beine gerade stehen damit Sie die Endwand ohne Problem nach her befestigen koennen. Nun befestigen Sie die Plane fuer die Eckbeine mit dem Haken am unterem Ende der Stange.

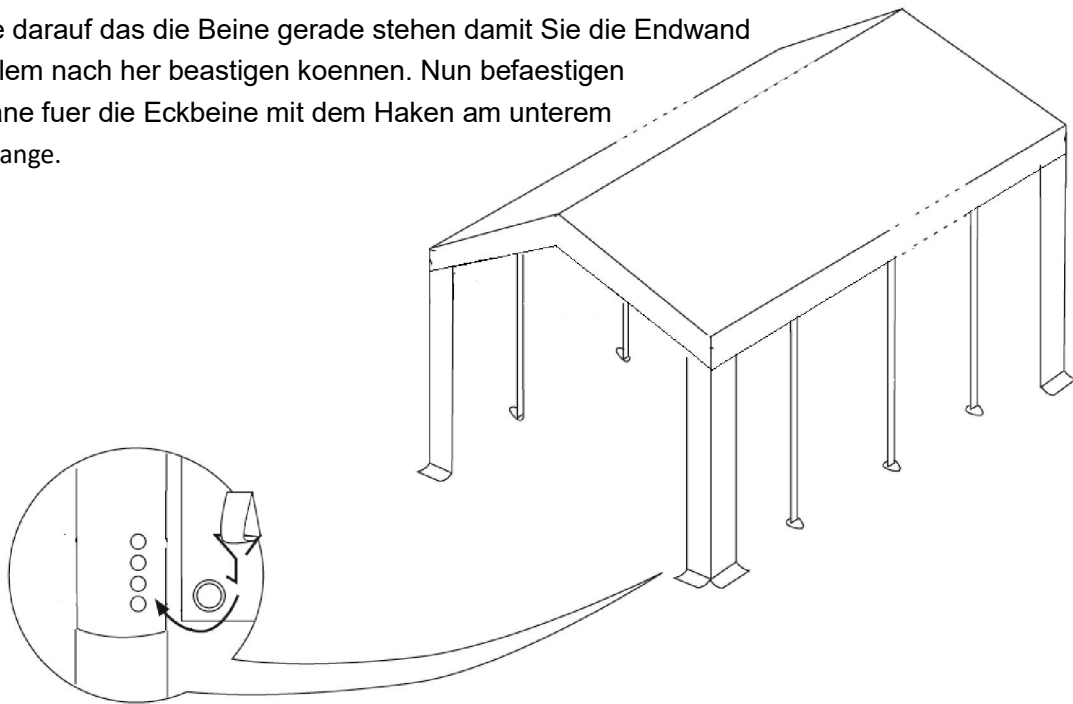

4. Entfalten Sie die Seitenwaende sowie die Vorder-und Rueckseitenwaende. Verbinden Sie diese mit den Spanngummis mit dem Gestell. Verbinden Sie die Seile mit den Haken am Boden. Achten Sie darauf die Seitenwaende und die Vor-Rueckwand mit dem Klettverschluss richtig zu Verbinden.

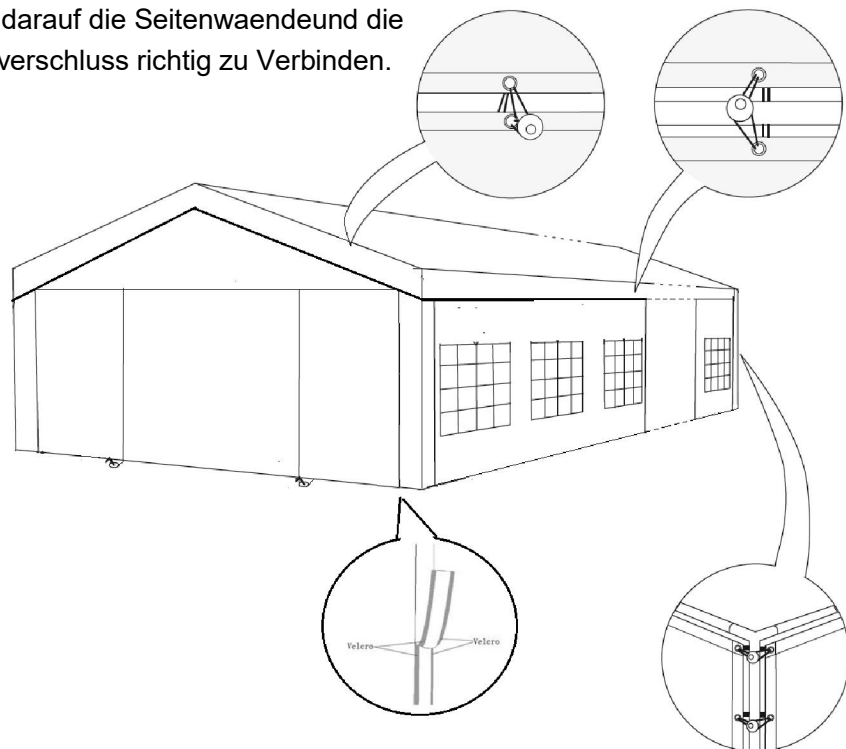

Anleitung zur Reinigung

Waschen Sie das Dach und alle Seitenwaende mit Seifenwasser. Benutzen Sie keine scharfen Reinigungsmittel.

Achten Sie darauf wenn Sie anderweitige Reinigungsmittel benutzen, die zb. Chlorenthalten, Prüfen Sie vorher an einer kleineren Stelle ob eine Verfaebung auftritt.

Wenn Sie das Zelt verstauen wollen, achten Sie darauf die Planen NIEMALS Nasszu verstauen.

Achtung!

1. Gehen Sie stets behutsam mit dem Zelt, um Schaden zu vermeiden.
2. Achten Sie darauf kein schweres Gewicht auf den Rahmen auszuuebnn um Schaden zu vermeiden.
3. Zelte sind nur fuer bestimmte Zeitraeume geeignet, deswegen achten Sie bitte auf die Wetterum-Staende und verstauen Sie das Zelt sorgfaeltig
4. Achten Sie darauf Distanz zu jeglichen Hochspannungsleitungen zu halten.
5. Wenn Sie eine geeignete Heizung haben, achten Sie darauf eine Entfernung von mindestens 1.20m von der Plane zu halten um das Schmoren zu vermeiden. Auf keinen Fall fuer offenes Feuer geeignet.
6. Die Person die das Zelt aufbaut ist fuer dessen Sicherhei zustaenig.